



■ Features

- Ultra slim design with 105mm(6SU) width
- Universal input 85~264VAC(277VAC operational)
- No load power consumption<0.3W
- Isolation class II
- DC output voltage adjustable
- Protections : Short circuit / Overload / Over voltage
- Cooling by free air convection
- DIN rail TS-35/7.5 or 15 mountable
- Over voltage category III
- LED indicator for power on
- 3 years warranty

■ Applications

- Household control system
- Building automation
- Industrial control system
- Factory automation
- Electro-mechanical apparatus

■ Description

HDR-150 is an economical ultra slim 150W DIN rail power supply series, adapt to be installed on TS-35/7.5 or TS-35/15 mounting rails. The body is designed 105mm(6SU) in width, which allows space saving inside the cabinets. The entire series adopts the full range AC input from 85VAC to 264VAC(277VAC operational) and conforms to EN61000-3-2, the norm the European Union regulates for harmonic current. HDR-150 is designed with plastic housing that it can effectively prevent user from electric hazards. With working efficiency up to 90.5%, the entire series can operate at the ambient temperature between -30°C and 70°C under air convection. The complete protection functions and relevant certificates for home automations and industrial control apparatus (IEC62368-1,UL62368-1,UL61010, EN61558-2-16) make HDR-150 a very competitive power supply solution for household and industrial applications.

■ Model Encoding

HDR - 150 - 12

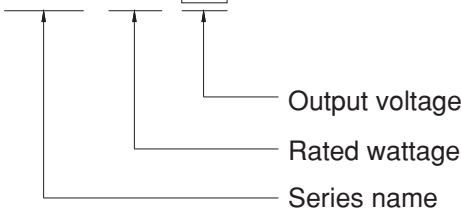



SPECIFICATION

MODEL	HDR-150-12		HDR-150-15		HDR-150-24		HDR-150-48			
OUTPUT	DC VOLTAGE		12V		15V		24V		48V	
	RATED CURRENT	115VAC	10.2A		8.55A		5.31A		2.72A	
		230VAC	11.3A		9.5A		6.25A		3.2A	
	RATED POWER	115VAC	122.4W		128.3W		127.4W		130.6W	
		230VAC	135.6W		142.5W		150W		153.6W	
	RIPPLE & NOISE (max.) Note.2		100mVp-p		120mVp-p		150mVp-p		200mVp-p	
	VOLTAGE ADJ. RANGE		10.8~ 13.8V		13.5 ~ 18V		21.6 ~ 29V		43.2 ~ 55.2V	
	VOLTAGE TOLERANCE Note.3		±2.0%		±1.0%		±1.0%		±1.0%	
	LINE REGULATION		±1.0%		±1.0%		±1.0%		±1.0%	
	LOAD REGULATION		±1.0%		±1.0%		±1.0%		±1.0%	
SETUP, RISE TIME		500ms, 60ms/230VAC		500ms, 60ms/115VAC at full load						
HOLD UP TIME (Typ.)		30ms/230VAC		12ms/115VAC at full load						
INPUT	VOLTAGE RANGE		85 ~ 264VAC (277VAC operational)		120 ~ 370VDC (390VDC operational)					
	FREQUENCY RANGE		47 ~ 63Hz							
	EFFICIENCY (Typ.)		89%		89.5%		90.5%		90.5%	
	AC CURRENT (Typ.)		3A/115VAC		1.6A/230VAC					
	INRUSH CURRENT (Typ.)		COLD START 35A/115VAC		70A/230VAC					
PROTECTION	OVERLOAD		105 ~ 135% rated output power		Hiccup mode when output voltage <50%, recovers automatically after fault condition is removed		Constant current limiting within 50% ~ 100% rated output voltage, recovers automatically after fault condition is removed			
	OVER VOLTAGE		14.2 ~ 16.2V		18.8 ~ 22.5V		30 ~ 36V		56.5 ~ 64.8V	
			Protection type : Shut down o/p voltage, re-power on to recover							
ENVIRONMENT	WORKING TEMP.		-30 ~ +70°C (Refer to "Derating Curve")							
	WORKING HUMIDITY		20 ~ 90% RH non-condensing							
	STORAGE TEMP., HUMIDITY		-40 ~ +85°C, 10 ~ 95% RH non-condensing							
	TEMP. COEFFICIENT		±0.03%/°C (0 ~ 45°C) RH non-condensing							
	VIBRATION		10 ~ 500Hz, 2G 10min./1cycle, period for 60min. each along X, Y, Z axes; Mounting: Compliance to IEC60068-2-6							
	OPERATING ALTITUDE		2000 meters (Note 4)							
	OVER VOLTAGE CATEGORY		III ; According to EN62368, EN61558, EN50178, EN60664-1, EN62477-1 ; altitude up to 2000 meters							
SAFETY & EMC (Note.7)	SAFETY STANDARDS		IEC62368-1, UL62368-1, UL61010, TUV EN61558-2-16, EAC TP TC 004 approved; Design refer to EN50178, TUV EN62368-1							
	WITHSTAND VOLTAGE		I/P-O/P:4KVAC							
	ISOLATION RESISTANCE		I/P-O/P:100M Ohms / 500VDC / 25°C / 70% RH							
	EMC EMISSION		Parameter		Standard		Test Level / Note			
			Conducted		EN55032(CISPR32)		Class B			
			Radiated		EN55032(CISPR32)		Class B (note 5)			
			Harmonic Current (Note 6)		EN61000-3-2		Class A			
			Voltage Flicker		EN61000-3-3		-----			
	EMC IMMUNITY		EN55024, EN61000-6-2							
			Parameter		Standard		Test Level / Note			
			ESD		EN61000-4-2		Level 3, 8KV air; Level 2, 4KV contact, criteria A			
			Radiated Susceptibility		EN61000-4-3		Level 3, criteria A			
			EFT/Burest		EN61000-4-4		Level 3, criteria A			
Surge			EN61000-4-5		Level 4, 2KV/L-N, criteria A					
Conducted			EN61000-4-6		Level 3, criteria A					
Magnetic Field			EN61000-4-8		Level 4, criteria A					
Voltage Dips and interruptions		EN61000-4-11		>95% dip 0. 5 periods, 30% dip 25 periods, >95% interruptions 250 periods						
OTHERS	MTBF		536K hrs min. MIL-HDBK-217F (25°C)							
	DIMENSION		105*90*54.5mm (W*H*D)							
	PACKING		0.31Kg; 32pcs/11Kg/1.0CUFT							
NOTE	<ol style="list-style-type: none"> All parameters NOT specially mentioned are measured at 230VAC input, rated load and 25°C of ambient temperature. Ripple & noise are measured at 20MHz of bandwidth by using a 12" twisted pair-wire terminated with a 0.1μf & 47μf parallel capacitor. Tolerance : includes set up tolerance, line regulation and load regulation. The ambient temperature derating of 3.5°C/1000m with fanless models and of 5°C/1000m with fan models for operating altitude higher than 2000m(6500ft). When the input voltage is 230VAC, delivers EMI Class B for radiated emission for the power supply; When the input voltage is 110VAC, delivers EMI Class A for radiated emission for the power supply. Harmonic current test at 70% load . The power supply is considered as an independent unit, but the final equipment still need to re-confirm that the whole system complies with the EMC directives. For guidance on how to perform these EMC tests, please refer to "EMI testing of component power supplies." (as available on http://www.meanwell.com) 									



150W Ultra Slim Step Shape DIN Rail

HDR-150 series

■ Block Diagram

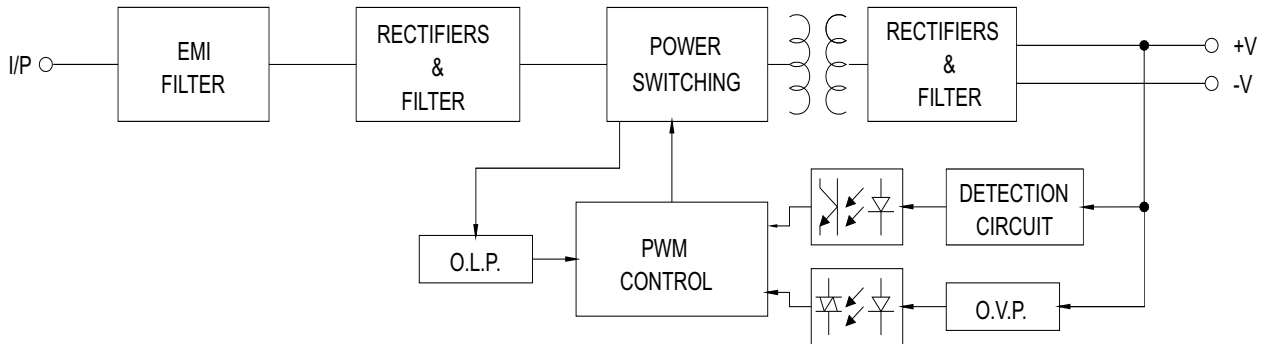

■ Derating Curve VS Ambient Temperature

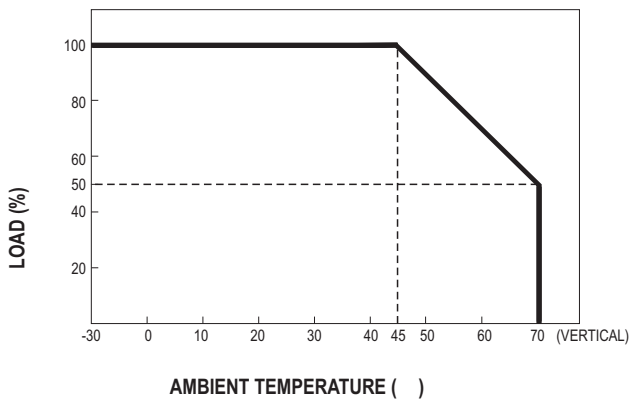

■ Output Derating VS Input Voltage

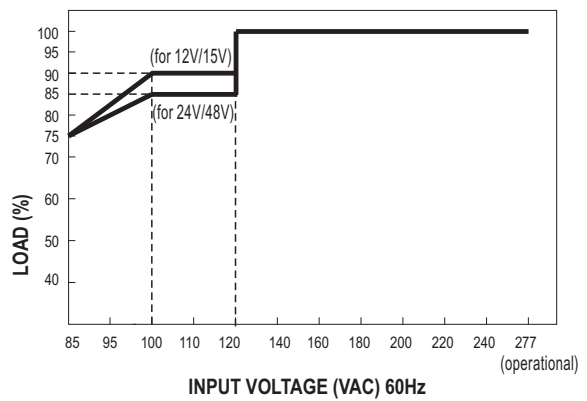



150W Ultra Slim Step Shape DIN Rail

HDR-150 series

Mechanical Specification

(Unit: mm , tolerance $\pm 0.5\text{mm}$)

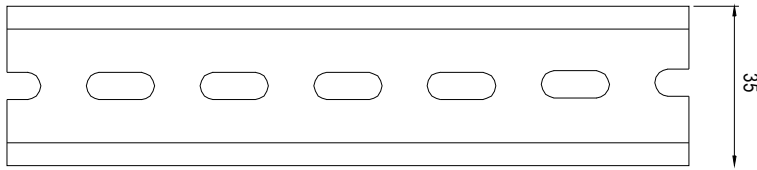
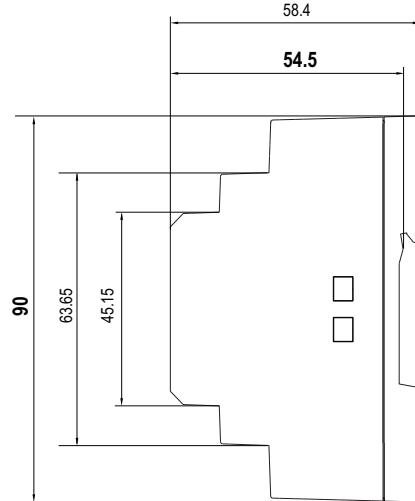
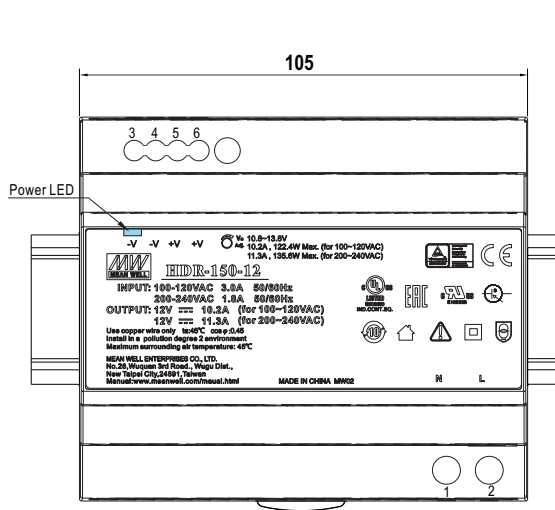

ADMISSIBLE DIN-RAIL: TS35/7.5 OR TS35/15

Terminal Pin No. Assignment

Pin No.	Assignment	Pin No.	Assignment
1	AC/N	3,4	-V
2	AC/L	5,6	+V

Installation Manual

Please refer to : <http://www.meanwell.com/manual.html>